

Article number: 2310431175

Description: E+G Levelling elements
LX.30-SW17-SST-M10X53

Measures

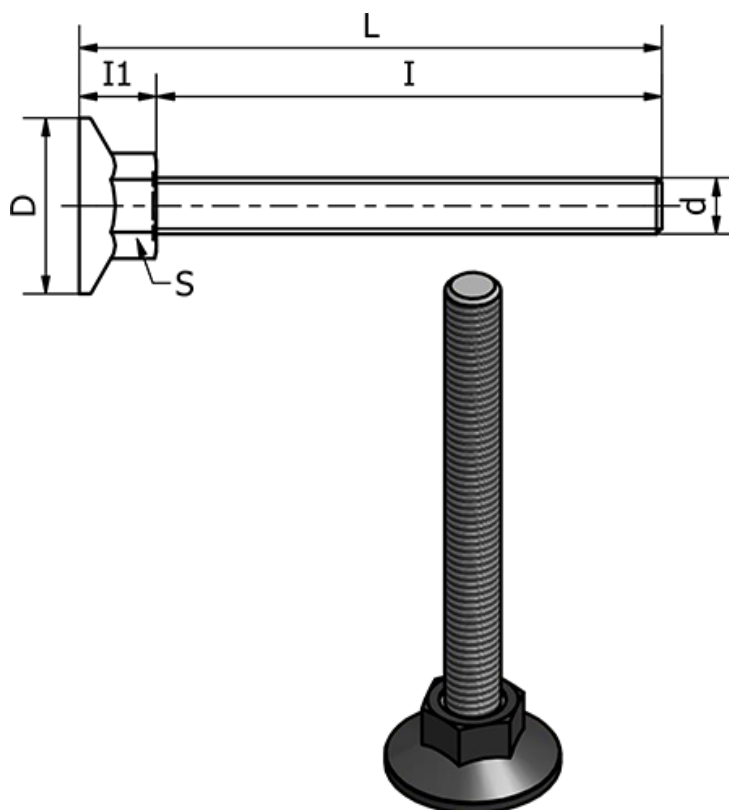

d = M10

D = 30

I = 53

I1 = 12

L = 63

S = 17

Static load in (N) = 3000

Type = AISI 304 Rustfast

Weight (g) = -